

SpiralAir®

High-flow Air Atomizing

DESIGN FEATURES

- A two-fluid nozzle using any gas as the atomizing fluid
- Three-stage atomization for highest performance
- Designed for high reliability in extremely hostile environments
- Efficient design reduces compressed air consumption

SPRAY CHARACTERISTICS

Spray patterns: Full Cone and Flat Fan
Spray angles: 20° to 90°
 (Other angles available by special order)
Flow rates: 2.0 to 80 l/min



1 1/2" SA (Set-up #) - A - 00

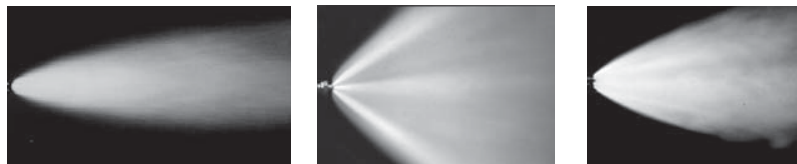

Narrow Round 20°

Wide Round 90°

Flat Fan 60°

Dimensions are approximate. Check with BETE for critical dimension applications.

SpiralAir Spray Set-up, Spiral Tip and Dimensions

Pipe Size	Spray Set-up No.	Spiral Tip No.	Spray Angle	Approx. Spray Type	Free Pass. Dia. (mm)	Pipe Size	Dimensions (mm)				Wt. (Kg)
							A	B	C	D	
1"	SA 101	14	20°	Narrow Round	4.83	1	148	50.8	50.8	50.8	0.64
	SA 308		90°	Wide Round	2.74						
	SA 310		60°	Round	2.74						
	SA 402	20	90°	Flat Fan	4.22						
	SA 404		60°		4.22						
	SA 103	28	20°	Narrow Round	7.14						
SA 307	90°		Wide Round	3.48							
SA 309	60°		Round	3.48							
SA 401	20		90°	Flat Fan	5.21						
SA 403			60°		5.21						
1 1/2"	SA 2100		28	20°	Narrow Round	9.27	1 1/2	229	50.8	55.6	113
	SA 2300	90°		Wide Round	5.41						
	SA 2301	60°		Round	5.41						

Standard Materials: 316 Stainless Steel with optional Cobalt Alloy 6 wear components.

Spray angle performance varies with pressure. Contact BETE for specific data on critical applications.

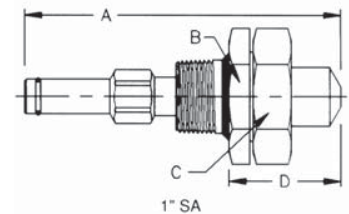

1" SA (Set-up #) - A - 00

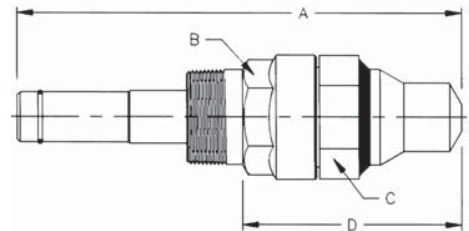

1 1/2" SA (Set-up #) - A - 00

Larger sizes and flow rates available upon request.

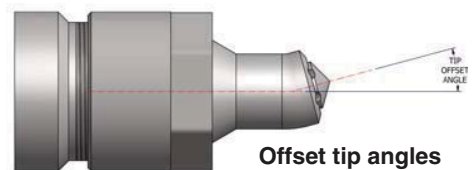
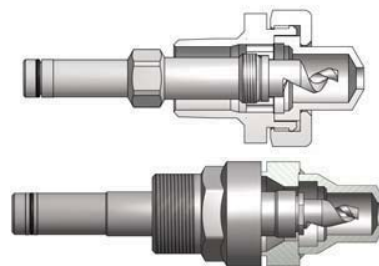

Offset tip angles available upon request

The SpiralAir can be configured to fit any installation requirement. The examples shown are just a few of the custom assemblies available. For more information, contact BETE Applications Engineering.

A guide with additional engineering data about the SpiralAir series is available on request.

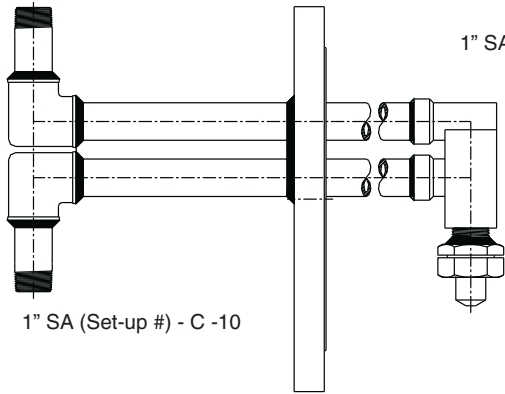
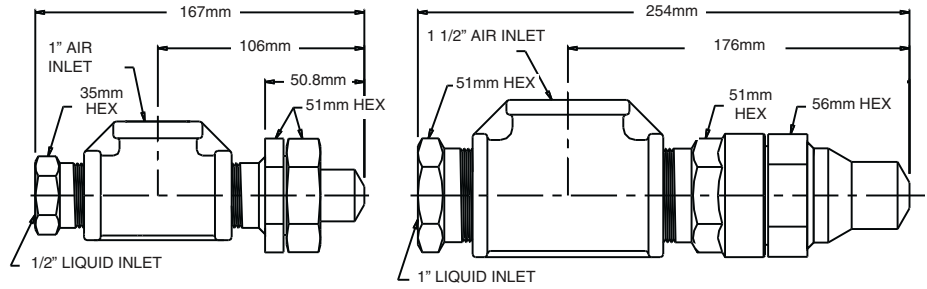

1" SA (Set-up #) - B -00

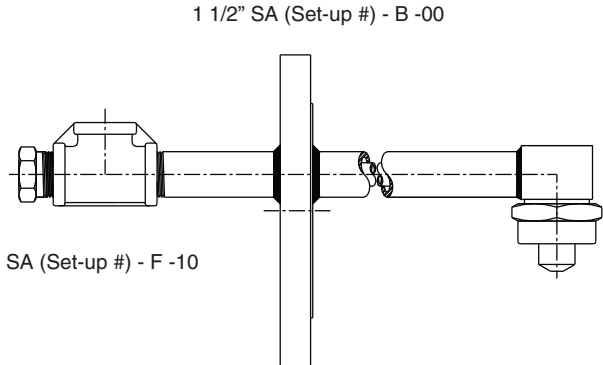

1 1/2" SA (Set-up #) - B -00

1" SA (Set-up #) - F -10

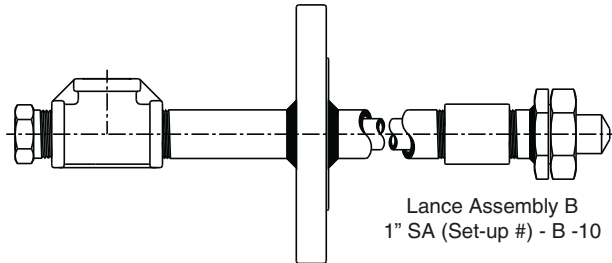

Lance Assembly B
1" SA (Set-up #) - B -10

Since very small variations in liquid pressure produce large variations in liquid flow, BETE recommends using a metering pump or other flow metering device to control the liquid flow.

SpiralAir Set-Up Flow Rates

Narrow, Wide and Flat Fan Patterns 1" and 1 1/2" BSP or NPT

BSP NPT	Spiral Tip Rating	2.0 bar air			3.0 bar air			4.0 bar air			5.0 bar air			6.0 bar air			7.0 bar air			
		liquid (l/min)	liquid (bar)	air (Nm ³ /h)	liquid (l/min)	liquid (bar)	air (Nm ³ /h)	liquid (l/min)	liquid (bar)	air (Nm ³ /h)	liquid (l/min)	liquid (bar)	air (Nm ³ /h)	liquid (l/min)	liquid (bar)	air (Nm ³ /h)	liquid (l/min)	liquid (bar)	air (Nm ³ /h)	
1"	14	2	1.8	47.1	2	2.7	77.9	2	3.7	110.3	2	4.7	144.0	2	5.9	179.2	2	7.1	215.8	
		3	1.9	36.1	3	2.8	59.8	3	3.8	84.6	3	4.8	110.5	3	6.0	137.5	3	7.2	165.7	
		4	2.0	29.9	4	2.9	49.6	4	3.9	70.1	4	4.9	91.6	4	6.1	114.0	4	7.3	137.3	
		5	2.1	25.8	5	3.0	42.8	5	4.0	60.6	5	5.0	79.2	5	6.2	98.6	5	7.4	118.7	
		6	2.1	22.9	6	3.1	38.0	6	4.1	53.8	6	5.1	70.3	6	6.3	87.5	6	7.5	105.4	
		7	2.2	20.7	7	3.1	34.4	7	4.1	48.7	7	5.2	63.6	7	6.4	79.1	7	7.6	95.3	
		8	2.3	19.0	8	3.2	31.5	8	4.2	44.6	8	5.3	58.3	8	6.5	72.5	8	7.7	87.4	
		9	2.3	17.6	9	3.3	29.2	9	4.3	41.3	9	5.4	54.0	9	6.5	67.2	9	7.8	80.9	
		10	2.4	16.4	10	3.3	27.2	10	4.3	38.5	10	5.4	50.4	10	6.6	62.7	10	7.9	75.5	
		11	2.4	15.4	11	3.4	25.6	11	4.4	36.2	11	5.5	47.3	11	6.7	58.9	11	7.9	71.0	
		12	2.4	14.6	12	3.4	24.2	12	4.4	34.2	12	5.6	44.7	12	6.8	55.7	12	8.0	67.1	
		1"	20	4	1.8	61.9	4	2.6	94.4	4	3.4	127.2	4	4.3	160.3	4	5.2	193.7	4	6.2
	8			2.0	43.0	8	2.7	65.4	8	3.6	88.1	8	4.5	111.0	8	5.4	134.1	8	6.4	157.5
	11			2.1	36.4	11	2.9	55.3	11	3.7	74.4	11	4.6	93.8	11	5.6	113.3	11	6.6	133.0
	15			2.2	30.9	15	3.0	46.9	15	3.8	63.2	15	4.8	79.5	15	5.7	96.1	15	6.7	112.8
	19			2.3	27.3	19	3.1	41.4	19	4.0	55.7	19	4.9	70.2	19	5.9	84.8	19	6.9	99.5
	23			2.4	24.7	23	3.2	37.5	23	4.1	50.4	23	5.0	63.4	23	6.0	76.6	23	7.0	89.9
	1 1/2"	28	26	2.5	23.1	26	3.3	35.1	26	4.2	47.2	26	5.1	59.4	26	6.1	71.8	26	7.1	84.2
30			2.5	21.5	30	3.4	32.6	30	4.2	43.8	30	5.2	55.1	30	6.1	66.5	30	7.2	78.1	
34			2.6	20.1	34	3.4	30.5	34	4.3	41.0	34	5.2	51.5	34	6.2	62.2	34	7.2	73.1	
38			2.6	19.0	38	3.5	28.7	38	4.4	38.6	38	5.3	48.6	38	6.3	58.7	38	7.3	68.9	
40			3.4	67.2	40	4.3	104.7	40	5.3	147.2	40	6.3	194.6	40	7.4	247.0				
45			3.5	61.3	45	4.4	95.6	45	5.4	134.4	45	6.4	177.7	45	7.5	225.5				
50			3.5	56.5	50	4.4	88.2	50	5.4	123.9	50	6.5	163.8	50	7.6	207.9				
55			3.6	52.5	55	4.5	81.9	55	5.5	115.2	55	6.5	152.2	55	7.6	193.1				
60			3.6	49.0	60	4.6	76.6	60	5.6	107.7	60	6.6	142.3	60	7.7	180.5				
65			3.7	46.1	65	4.6	72.0	65	5.6	101.3	65	6.7	133.8	65	7.8	169.7				
70	3.7	43.5	70	4.7	68.0	70	5.7	95.6	70	6.7	126.4	70	7.8	160.2						
75	3.8	41.2	75	4.7	64.5	75	5.7	90.7	75	6.8	119.8	75	7.9	151.9						
80	3.8	39.2	80	4.7	61.4	80	5.7	86.3	80	6.8	114.0	80	8.0	144.5						

Standard Materials: 316 Stainless Steel with optional Cobalt Alloy 6 wear components

Spray angle performance varies with pressure. Contact BETE for specific data on critical applications.